

FL-BC3518-9M Product Specifications

Resolution	9 Mega-pixel *1	
Format size	1" format	
Focal length	35mm	
Maximum aperture ratio	1:1.8	
Iris range	1.8~22	
Mount	C	
Horizontal angle of view	1/3" format	7.8°
	1/2" format	10.4°
	1/1.8" format	11.7°
	2/3" format	14.3°
	1" format	20.7°
Minimum object distance	0.15m	
Back focal length	16.8mm	
Filter size	40.5 P=0.5mm	
Dimensions	φ42mmx60.5mm	
Weight	150g	
Remarks	Focus & Iris lock screws	

*1 The lens is also suitable to 4 megapixel and 6 megapixel cameras.

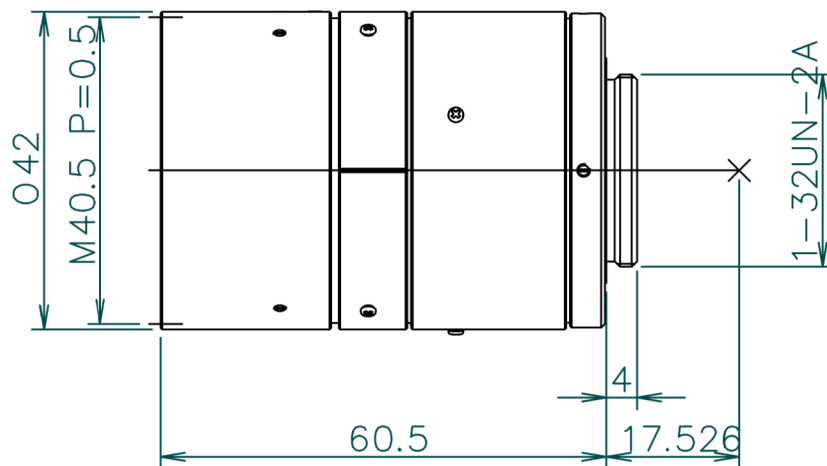

bestscientific.co.uk

For more information, contact Best Scientific
t: +44 (0)1793 812477 | e: enq@bestscientificweb.com